

PATPET

User Manual

P-305

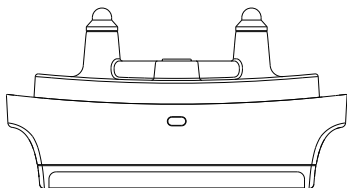

Important Safety Information

Remote dog training collar is designed to let dogs live safely, happily and get along with people more harmoniously.

⚠️ WARNING Do not use with aggressive dogs.

Aggressive dogs may cause severe injury and even death to their owners and others. If you are unsure whether this product is appropriate for your dog, please consult your veterinarian or certified trainer.

⚠️ CAUTION Safety during on-leash training.

It is vitally important that you and your dog remain safe while learning during on-leash training. Your dog should be on a strong leash, long enough for him to attempt to chase an object, but short enough for him not to reach a road or other unsafe area. You must also be physically strong enough to restrain your dog when he tries to chase.

⚠️ CAUTION Risk of skin damage.

Please read and follow the instructions in this manual. Proper fit of the collar is important. A collar worn for too long or made too tight on the pet's neck may cause skin damage ranging from redness to pressure ulcers. This condition is commonly known as bed sores.

- Avoid leaving the collar on the dog for more than 12 hours per day.
- When possible reposition the collar on the pet's neck every 1 to 2 hours.
- Never connect a lead to the electronic collar; it will cause excessive pressure on the contacts.
- If a rash or sore is found, discontinue use of the collar until the skin has healed.
- If the condition persists beyond 48 hours, see your veterinarian.
- This product is not a toy, please keep away from children.
- This product is only for use with healthy dogs.

Overview

Remote

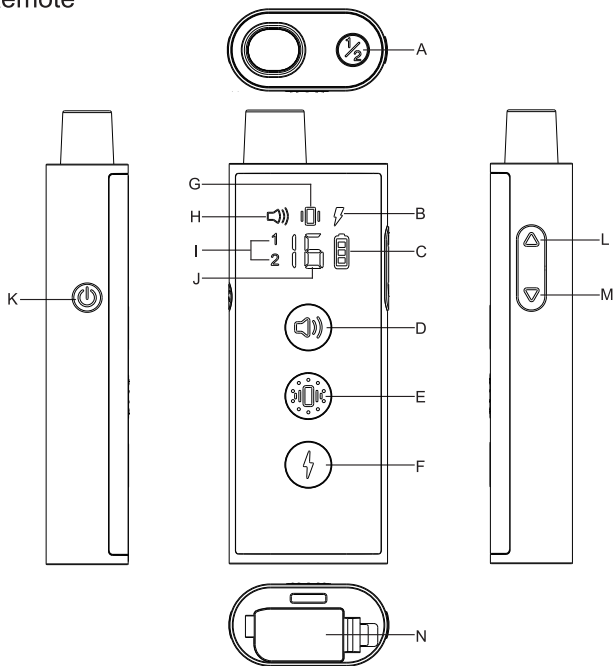

A. Channel Switch Button

B. Shock Icon

C. Battery Capacity Display

D. Tone Button

E. Vibration Button

F. Shock Button

G. Vibration Icon

H. Tone Icon

I. Channel Display

J. Shock Level Display

K. On/Off Button

L. Shock Level +

M. Shock Level -

N. Battery Cover

Receiver Collar

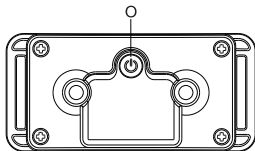
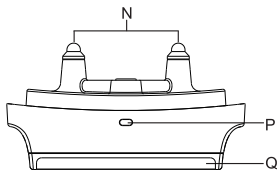

- N . Contact Points
- O . On/Off Button
- P . LED Indicator
- Q . Battery Cover

Setting Up the Product

Before using the Dog Training Collar, follow the steps below to set up the product.

Prepare the Remote

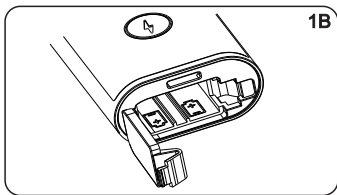
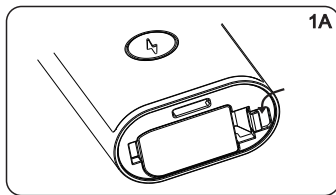

Install battery on the Remote

1. Open the battery cover bayonet in the direction of the arrow(1A).
2. Erect the battery cover vertically(1B).
3. Install the battery according to the engraved mark, negative (-) first, positive(+) next(1C).
4. Put the battery cover back and clip it(1D).

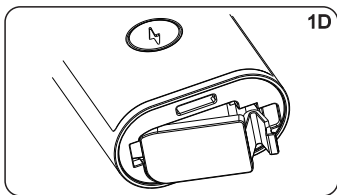
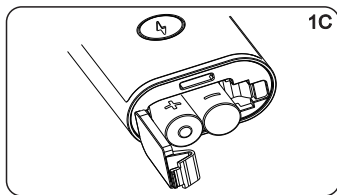



Turn ON/OFF the Remote

1. Press  on the Remote once to turn it ON.
2. LED will be lighted, and show the information of current channel, battery power and levels. If not, please check the batteries position or change new batteries.
3. Press and hold  again on the Remote to turn it OFF until the LED display goes off, then release. It may take 2-3 seconds.
4. When the remote is on, the LED display will light up if any button is pressed.

Prepare the Receiver

Install battery

1. Slide the battery cover away from the marked position in the direction of the arrow and remove the battery cover(2A).
2. Refer to battery compartment positive and negative identification and install the battery correctly(2B).
3. Install the battery cover into the main body in the direction of the arrow and press it tightly(2C).
4. Push the battery cover in the direction of the arrow and flush with the body(2D).

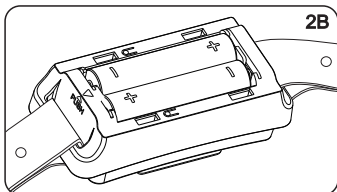
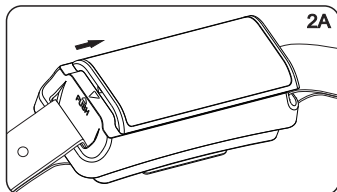

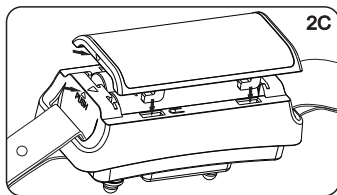

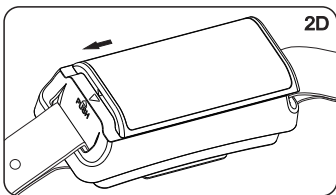

2C



2D

Turn ON/OFF Receiver Collar

1. Press  and the Green LED light will come on.
2. In normal mode, the Green LED will flash every 4 seconds, indicating the Receiver Collar is on and ready to receive signal from the Remote.
3. Press and hold  until the Red LED light shuts off (This takes approximate 3 seconds), which means the device has turned off.

NOTE: To extend the life of the batteries, please turn the Receiver Collar off when it is not in use. Remove the battery if you don't use it for a long time.

Assemble Collar Strap

1. Push the Lock catch to the direction show in picture 3A, then pull the lock up and down to adjust to the elastic rope.
2. After the elastic rope is adjusted to the appropriate size, push the lock catch back to fix the collar length as show in picture 3B.

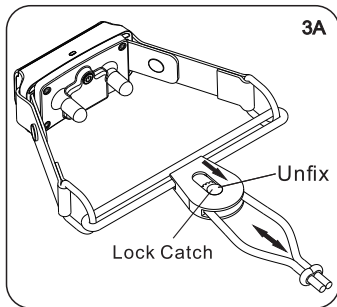

3A

Unfix
Lock Catch

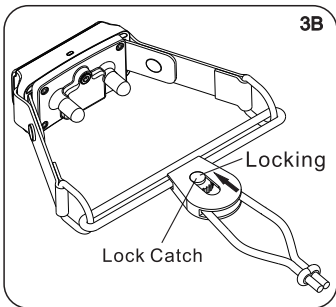









3B

Locking
Lock Catch

Function Test

We recommend you to experience the different shock levels firsthand on yourself. Please begin at the lowest level, then increase levels gradually to your personal comfortable level. You can do as below.

1. Place 2 fingers over both contact points of the training collar.
2. Hold your remote approximately 2 ft from the receiver collar. Press the Shock Button continuously for 1 to 2 seconds. You should feel continuous Shock.
3. Press  /  to adjust levels.
4. Increase the level until the sensation begins to feel uncomfortable.

	Vibration: Send a vibration to the Receiver Collar.
	Tone: Send a tone with non-adjustable level to the Receiver Collar.
	Shock: Send shock command ranging 1-16 to the Receiver Collar.
	2 dogs mode Channel Switch: Press shortly once to switch dog 1 and dog 2 channel.
	Increase the Shock Level.
	Decrease the Shock Level.
	On/Off Button

- NOTE:**
1. The Shock Level can be adjusted from 1 to 16 levels, please adjust it properly as per your dog's reaction.
 2. Don't press and hold the Vibration/Shock Button too long, avoiding physical or psychological hurt to the dog.
 3. For 5 min no operation, the receiver will enter deep sleep mode. In this case, you need to press any button to wake it up when reuse.

How to Use the Test Lamp

Shock Function Test

1. Turn on the Receiver Collar.
2. Hold the Test Lamp contacts against the Contact Points (or Conductive Silicone Covers).
3. Press the Shock Button and the Test Lamp will be lighted. It will be brighter as the Shock Level is increased.

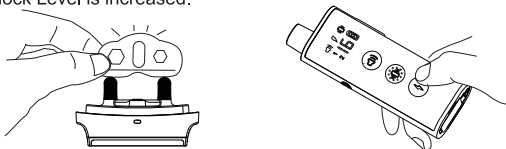

Pair the Remote and the Receiver Collar

1. Use the Dog $\frac{1}{2}$ Button on the Remote to select Dog 1 .
2. With the Remote turned on and the Receiver Collar turned off, press and hold the ON/OFF Button on the Receiver collar for 4-5 seconds.
3. The Red & Green LED will blink for about 10 seconds indicating that the receiver is ready for pairing.
4. Press and hold the first Tone Button and the second Vibration Button at the same time for 2-3 seconds, when the LED on the Receiver Collar flashes green for 5 times indicating successful pairing.

Pairing a Second Collar with the Remote

1. If the remote only is dog 1 mode, you need to unlock the dog 2 mode: press $\frac{1}{2}$ and ∇ key at same time and hold 5 second. (repeat this operation to lock dog 2 again)
2. Short press $\frac{1}{2}$ Button on the Remote to select Dog 2 . Then follow the above pairing steps 2-4.

Fit the Training Fitting

Important: The proper fit and placement of your training collar is important for effective operation. The contact points must have directly touched your dog's skin on the underside of his neck.

1. Start with the collar turned off and your dog standing comfortably, not sitting(A).
2. Put the training collar under your dog's chin, make sure the contact points touch the center of your dog's neck, and then touch the dog gently (B) .

NOTE: It's sometimes necessary to trim the hair around the contact points to make sure that contact is consistent. We've also included longer contact points.

CAUTION Do not shave the pet's neck as this may increase the risk of skin irritation. The training collar should not be worn for more than 12 hours out of every 24-hour period. Leaving the training collar on too long could lead to skin irritation. Remove the collar when you're not training your dog.

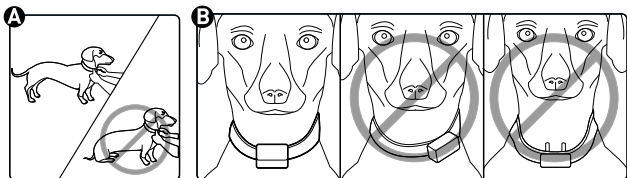

Find the Best Shock Level for Your Pet

The unit comes with Up and Down buttons to control the Shock Level, with Level 1 being the lowest level and Level 16 being the highest. The most suitable shock level depends on your dog's temperament and threshold for Shock. Always start at the lowest level and work your way up. The appropriate level can be found when the dog responds to the Shock with a mild reaction, such as a flick of the ear, a lick of the lips, a tensing of the neck muscles etc. The Shock Level may vary depending on the training situation. When highly distracted, dogs will require a higher level of Shock.

NOTE: Continuous stimulation will be no more than 10s, because the system will go into automatic protection.

Product Information

Product Specification

Battery Type	AAA(LR03) Alkaline battery
Battery Life(typical use)	Remote: 60 days Receiver: 30 days
Remote Waterproof Rating	Non-Waterproof(Keep away from water)
Receiver Waterproof Rating	IEC 60529 IPX7
Operating temperature range	From 0-40°C(from 32-104°F)
Wireless Power	10mW
Wireless Range	300m(984 feet)

The batteries need replaced under the situations below

1. The indicator light on the Receiver Collar is emitting a red color every 4 seconds or flashes rapidly.
2. The battery icon on the Remote LED shows just 1 bar.(When battery is low, the shock function will be affected.)
3. The indicator light on the Remote or Receiver Collar will not come on.
4. The indicator light on the Remote or Receiver Collar comes on momentarily when any of the Mode Buttons is pressed.

Frequently Asked Questions

Is the Vibration/Shock safe for my pet?	While the Vibration/Shock is unpleasant, it is harmless to your pet. Electronic training devices require interaction and training from the owner to achieve desired results.
How old does my pet have to be before using the Remote Training Collar?	Your pet should be able to recognize basic obedience commands such as "Sit" or "Stay". Pets should be at least 6 months old before using the Training Collar.
Once my pet is trained and has been obeying my commands, will he have to continue to wear the Receiver Collar?	Probably not. But you need to reinforce the behaviors with adding treats and praise. After all, the object of training collar is not to use it finally.
Is the Receiver Collar water resistant?	Yes.
Will I get exactly 984 feet of range with the Remote Training Collar?	The range of the Remote Training will vary according to terrain, weather, vegetation, as well as transmission from other radio devices.

<p>How long can I continuously deliver Vibration/Shock to my pet?</p>	<p>The maximum amount of time you can press the Vibration/Shock Button and deliver Vibration/Shock to your pet continuously is 10 seconds. After this, there will be a pause, the signal cannot be transmitted for about 5 seconds. After the 5 second time-out period, Button can be pressed and Vibration/Shock can be delivered again.</p>
--	---

Troubleshooting Guide

<p>My pet does not respond when I press a button.</p>	<ul style="list-style-type: none"> • Make sure the Receiver Collar has been turned on. • If your range has reduced from the first time you used the Remote Training Collar, the battery(s) may be low in either the Remote or Receiver Collar. • Terrain, weather, vegetation, transmission from other radio devices and many other factors can impact the amount of range you have with the unit. • Test the Receiver Collar. See “How to use the Test Lamp” for details. • Increase the Shock Level. Refer to “Find the Best Shock Level for Your Pet” for more information. • Make sure the Receiver Collar’s Contact Points are placed snugly against your pet’s skin. Refer to “Fit the Training Collar” for more informations.
<p>The Receiver Collar will not turn on.</p>	<ul style="list-style-type: none"> • Check that two LR03/AAA batteries have been installed properly. See “Install battery on the Receiver”.
<p>The Receiver Collar is not responding to the Remote.</p>	<ul style="list-style-type: none"> • Make sure the Receiver Collar is on. • If the Indicator Light does not come on when any button is pressed on the remote, ensure that the batteries are inserted properly. • If the first two solutions did not resolve your problem, see “Pair the Remote and the Receiver Collar”.

Warranty and repair information

1-Year Limited Lifetime Warranty

The original purchaser for this unit is provided with 1-YEAR WARRANTY. The warranty begins from the date of purchase. For the first year, coverage is for both Parts and Labor on warranty repair services.

Accessories such as straps and batteries are covered for the first year only. After the first year, the Limited Lifetime Warranty covers Parts only and does not cover Labor Fees and Accessories. All shipping fees incurred, the cost of Accessories after the first year, and Labor fees associated with out of warranty repair work, are the customer's responsibility. Labor fees will be variable depending on the extent of the work required. The Limited Lifetime Warranty expires after 5 years when a model is discontinued from production.

To Qualify for the Warranty

A proof of purchase is required for all products to initiate repair work under warranty. We strongly recommend keeping the original receipt. If a proof of purchase is not available at the time of service, we will estimate the age of unit by the serial number, which may differ from the actual purchase date, but the serial number is also the only method of determining an approximate date of purchase without a proof of purchase.

Not Covered Under Warranty

We DO NOT offer warranty for products that have been bought secondhand or as a resold product. We DO NOT replace defective units or provide refunds for products purchased from us after 30 days from the date of purchase. Issues of replacement and refunds on units purchased less than 30 days from an authorized dealer must be addressed to the dealer directly. If the products purchased from an authorized dealer are after 30 days from the date of purchase, please send the units to us for service and repair. We DO NOT cover the cost of repairs and replacements due to misuse by the owner or dog, improper maintenance, and/or lost units. Any water damage on the Water Resistant remote and the Water Resistant Receiver of our product series will not be covered. All replacement costs for either the remote or receiver will be the owner's responsibility. The warranty is void if the unit has been altered or an unauthorized

person has damaged the unit while attempting repair work. We reserve the right to retain and discard any parts or accessories that have been found damaged upon replacement and repair.

Procedure for Repair Work

If the unit is malfunctioning, please refer to the “Troubleshooting Guide” in the quick start before sending it back for Service. The postage of shipping to us under warranty is the customer’s responsibility. We are not responsible for units damaged or lost in transition. We are not responsible for loss of training time or inconvenience while the unit is in for repair work. We do not provide loaner units or any form of compensation during the repair period. A copy of the sales receipt showing the purchase date may be required before warranty work is initiated. Please include a brief explanation outlining the problem and include your name, address, city/state/zip code, daytime phone number, evening phone number, and email address.

Compliance

FCC - USA

This device complies with part 15 of the FCC Rules. Operation is subjected to the following two conditions:

- (1) This device may not cause harmful interference.
- (2) this device must accept any interference received, including interference that may cause undesired operation.

CAUTION: Modification or dismantling to this equipment not expressly approved by Manufacture may void the user’s authority to operate the equipment.

NOTE: This equipment has been tested and found to comply with the limits for a Class B digital device, pursuant to part 15 of the FCC Rules. These limits are designed to provide reasonable protection against harmful interference in a residential installation. This equipment generates uses and can radiate radio frequency energy and, if not installed and used in accordance with the instructions, may cause harmful interference to radio communications. However, there is no guarantee that interference will not occur in a particular installation. If this equipment does cause harmful interference to radio or television reception, which can be determined by turning the equipment off and on, the user is encouraged to try to correct the interference by one or more of the following measures:

- Increase the separation between the equipment and receiver.
- Connect the equipment into an outlet on a circuit different from that to which the receiver is connected.
- Consult the dealer or an experienced radio/TV technician for help.

PATPET

Shenzhen Patpet Technology Co.,Ltd

 <https://patpet.com/>

 Become a dealer: inquiry@patpet.com

 After-service: support@patpet.com

 [@PatpetDogCollar](#)

 Youtube Video Guide



MADE IN CHINA